

Spare parts list Pneumatic breaker

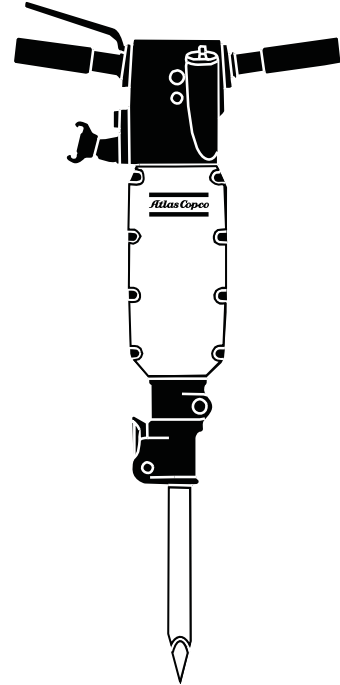

Contents

SPARE PARTS LIST	5
WORKING TOOLS	10
WORKING TOOLS - US MODELS	11
SERVICE KIT 3310 1175 91	12
SERVICE KIT 3310 1175 90	12
AIR-OIL	13
SHANK GAUGE.....	13

Spare parts list

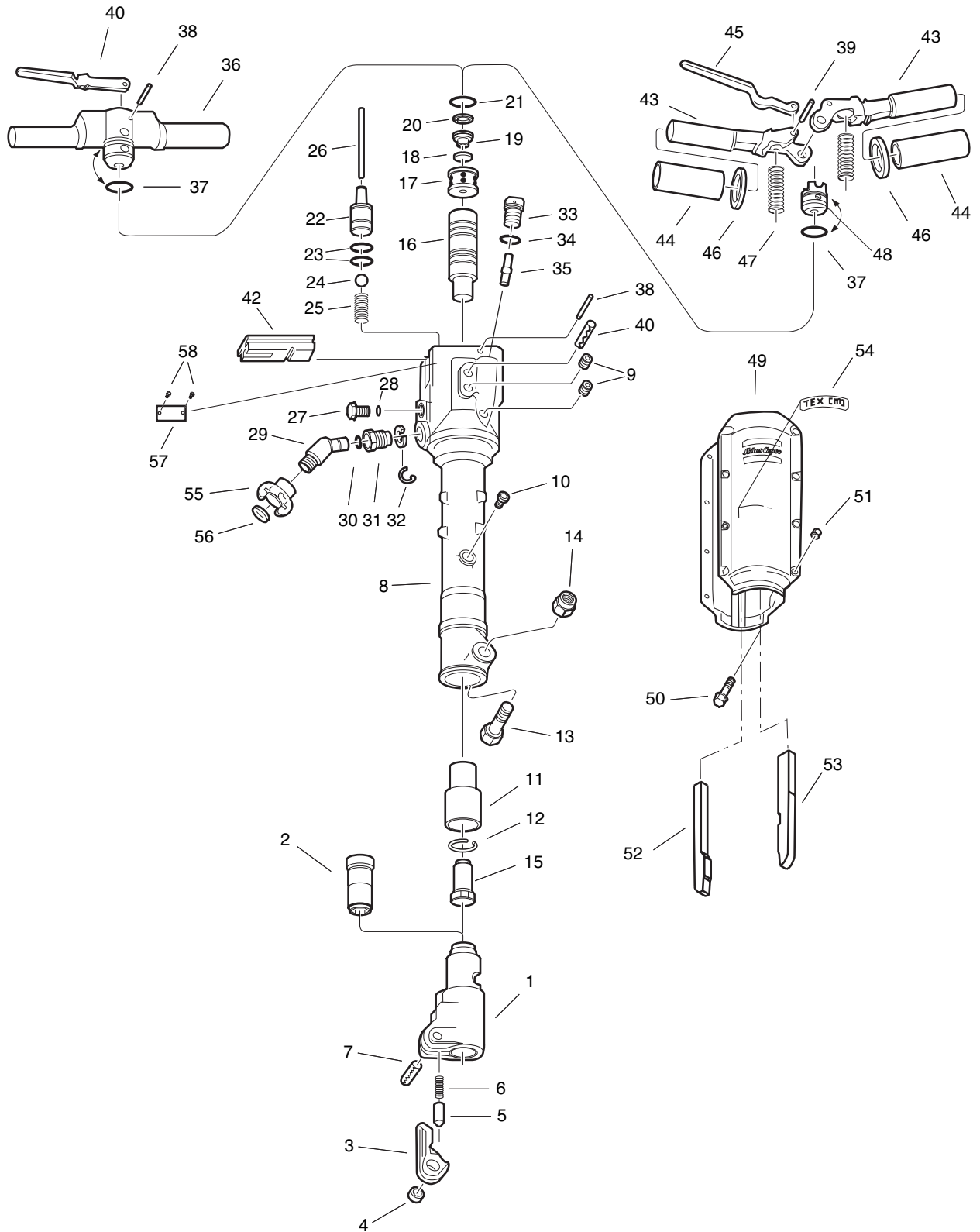

No.	Ordering No.	Quantity						Description	Dimensions
		18PS	19PE	22PS	23PE	27PS	28PE		
(1-2)	3310 1068 80	1	1	1	1	-	-	Fronthead, compl., ISO models	25x108 mm
1	—*)	1	1	1	1	-	-	- Fronthead	
2	3310 1205 00	1	1	1	1	-	-	- Chuck	25x108 mm
1	3310 1080 01	1	1	1	1	1	1	Fronthead, All models	28x160 mm
1	3310 1080 00	-	-	1	1	1	1	Fronthead, All models	32x160 mm
(1-2)	3310 1068 81	1	1	-	-	-	-	Fronthead, compl., US models	25x108 mm
1	—*)	1	1	-	-	-	-	- Fronthead	
2	3310 1205 00	1	1	1	1	-	-	- Chuck	25x108 mm
(1-2)	3310 1068 82	1	-	-	-	-	-	Fronthead, compl., US models	22x82.5 mm
1	—*)	1	-	-	-	-	-	- Fronthead	
2	3310 1342 00	1	-	-	-	-	-	- Chuck	22x82.5 mm
(3-4)	3310 0890 80	1	1	1	1	1	1	Tool retainer, compl.	
3	—*)	1	1	1	1	1	1	- Tool retainer	
4	3310 0891 00	1	1	1	1	1	1	- Bushing	
5	3310 1069 00	1	1	1	1	1	1	Plunger	
6	3310 0894 00	1	1	1	1	1	1	Spring	
7	0108 1691 05	1	1	1	1	1	1	Connex pin	Ø16x50
(8-10)	3310 1108 00	1	1	-	-	-	-	Cylinder, compl., 18 PS, 19PE	
8	—*)	1	1	-	-	-	-	- Cylinder	
9	0686 6102 00	2	2	-	-	-	-	- Screw plug	ISO 7-R1/4
10	0686 6103 00	1	1	-	-	-	-	- Screw plug	ISO 7-R3/8
(8-10)	3310 1067 00	-	-	1	1	-	-	Cylinder, compl., 22PS, 23 PE	
8	—*)	-	-	1	1	-	-	- Cylinder	
9	0686 6102 00	-	-	2	2	-	-	- Screw plug	ISO 7-R1/4
10	0686 6103 00	-	-	1	1	-	-	- Screw plug	ISO 7-R3/8
(8-10)	3310 1088 00	-	-	-	-	1	1	Cylinder, compl., 27PS, 28PE	
8	—*)	-	-	-	-	1	1	- Cylinder	
9	0686 6102 00	-	-	-	-	2	2	- Screw plug	ISO 7-R1/4
10	0686 6103 00	-	-	-	-	1	1	- Screw plug	ISO 7-R3/8
11	3310 1111 00	1	1	-	-	-	-	Intermediate part	
11	3310 1074 00	-	-	1	1	-	-	Intermediate part	
11	3310 1091 00	-	-	-	-	1	1	Intermediate part	
12	3310 1071 00	1	1	1	1	1	1	Lock ring	
13	3310 1175 00**)	1	1	1	1	1	1	Bolt	MJ20x100 mm
14	0291 1116 00**)	1	1	1	1	1	1	Nut	M20 Nyloc
15	3310 1200 00	1	1	-	-	-	-	Anvil	
15	3310 1201 00	-	-	1	1	-	-	Anvil	
15	3310 1202 00	-	-	-	-	1	1	Anvil	
16	3310 1195 00	1	1	-	-	-	-	Piston	
16	3310 1196 00	-	-	1	1	-	-	Piston	
16	3310 1197 00	-	-	-	-	1	1	Piston	
(17-20)	3310 1165 90	1	1	-	-	-	-	Valve system, compl., 18PS, 19PE	Blue Ø51
17	—*)	1	1	-	-	-	-	- Valve housing	
18	3310 1173 00	1	1	-	-	-	-	- Main valve	
19	3310 1163 00	1	1	-	-	-	-	- Valve cover	
20	3310 1164 00	1	1	-	-	-	-	- Steel washer	Ø51

*) Not delivered separately.

**) Included in Service kit 3310 1175 90/91, see page 12.

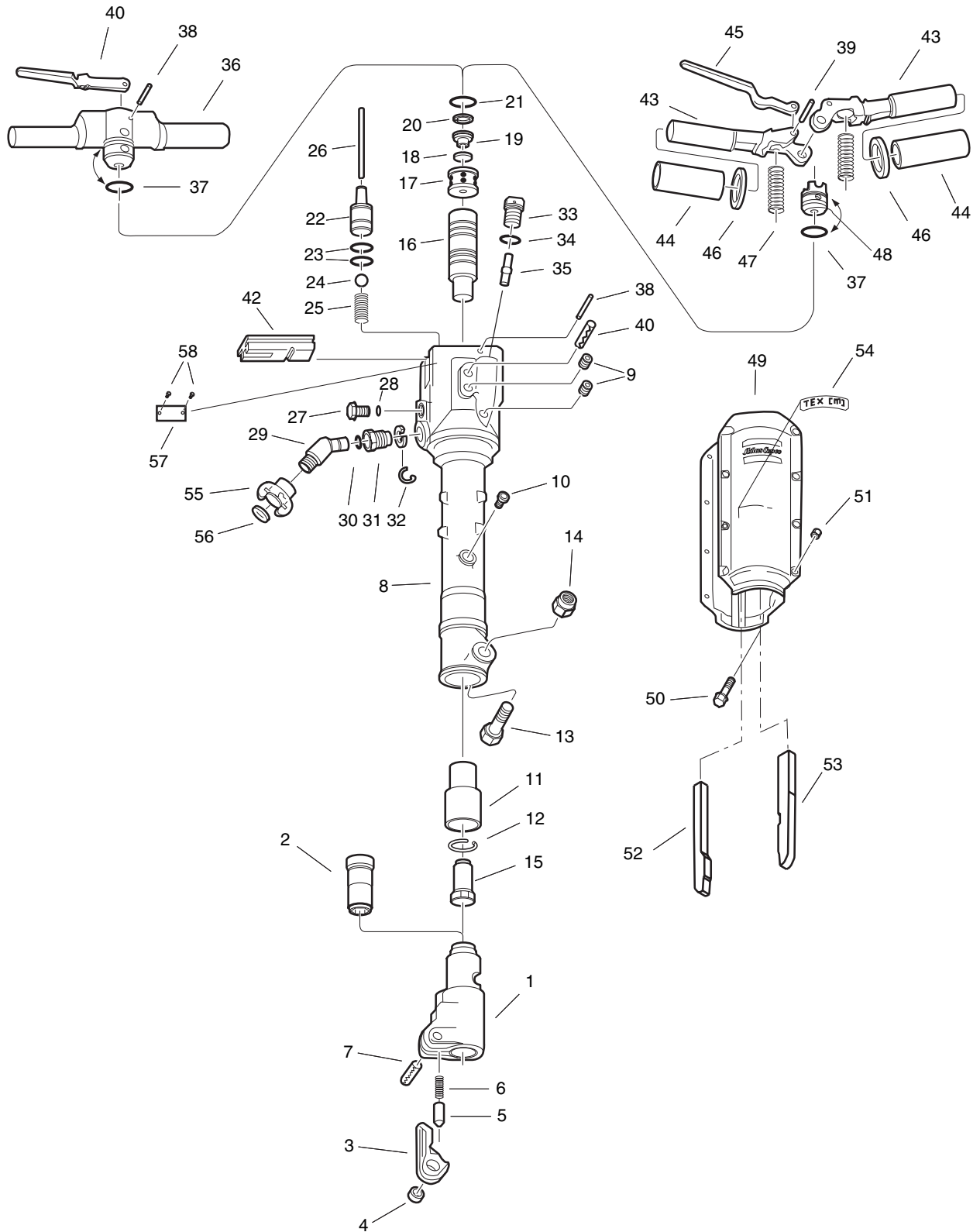

No.	Ordering No.	Quantity						Description	Dimensions
		18PS	19PE	22PS	23PE	27PS	28PE		
(17-20)	3310 1167 90	-	-	1	1	-	-	Valve system, compl., 22PS, 23PE	Black Ø51
17	— *)	-	-	1	1	-	-	- Valve housing	
18	3310 1173 00	-	-	1	1	-	-	- Main valve	
19	3310 1163 00	-	-	1	1	-	-	- Valve cover	
20	3310 1164 00	-	-	1	1	-	-	- Steel washer	Ø51
(17-20)	3310 1168 90	-	-	-	-	1	1	Valve system, compl., 27PS, 28PE	Red Ø51
17	— *)	-	-	-	-	1	1	- Valve housing	
18	3310 1173 00	-	-	-	-	1	1	- Main valve	
19	3310 1163 00	-	-	-	-	1	1	- Valve cover	
20	3310 1164 00	-	-	-	-	1	1	- Steel washer	Ø51
21	0663 2101 09**)	1	1	1	1	1	1	O-ring	Ø40.64x5.33
22	3310 1078 00	1	1	1	1	1	1	Valve seat	
23	0663 2105 43**)	2	2	2	2	2	2	O-ring	Ø27.6x2.4
24	3310 0983 00	1	1	1	1	1	1	Ball	Red Ø20
25	3310 1079 00	1	1	1	1	1	1	Spring	
26	3310 1039 00	1	1	1	1	1	1	Valve stem	
27	3310 1042 00	1	1	1	1	1	1	Screw plug	
28	0663 2116 00**)	1	1	1	1	1	1	O-ring	Ø9.3x2.4
29	3310 1043 00	1	1	1	1	1	1	Swivel, ISO models	G 3/4A
29	3310 1043 01	1	1	1	1	1	1	Swivel, US models	3/4 - 14 NPT
30	0663 2126 00**)	1	1	1	1	1	1	O-ring	Ø22.2x3
31	3310 1044 00	1	1	1	1	1	1	Swivel nut	
32	3310 1059 00	1	1	1	1	1	1	Lock washer	
(33-34)	3310 1538 80	1	1	1	1	1	1	Oil plug, compl.	
33	— *)	1	1	1	1	1	1	- Oil plug	G 3/4 A
34	0663 2126 00**)	1	1	1	1	1	1	- O-ring	Ø22.2x3
35	3310 1295 00	1	1	1	1	1	1	Dosing feeder	
36	3310 1309 00	1	-	1	-	1	-	Handle, 18PS, 22PS, 27PS	
37	0663 2135 00**)	1	1	1	1	1	1	O-ring	Ø44.2x3.0
38	0102 0320 00	1	-	1	-	1	-	Pin	Ø6x25
39	0108 1330 00**)	1	2	1	2	1	2	Spring pin	Ø6x32
40	3310 1046 00	1	-	1	-	1	-	Trigger	
41	0108 1690 86**)	1	1	1	1	1	1	Connex pin	Ø16x85
42	3310 1076 00	1	1	1	1	1	1	Cover	
(43-44)	3310 1081 80	-	2	-	2	-	2	Handle, compl., 19PE, 23PE, 28PE	
43	— *)	-	2	-	2	-	2	- Handle	
44	3310 1132 00**)	-	2	-	2	-	2	- Sleeve	
45	3310 1082 00	-	1	-	1	-	1	Trigger	
46	3310 1085 00**)	-	2	-	2	-	2	Rubber washer	

*) Not delivered separately.

**) Included in Service kit 3310 1175 90/91, see page 12.

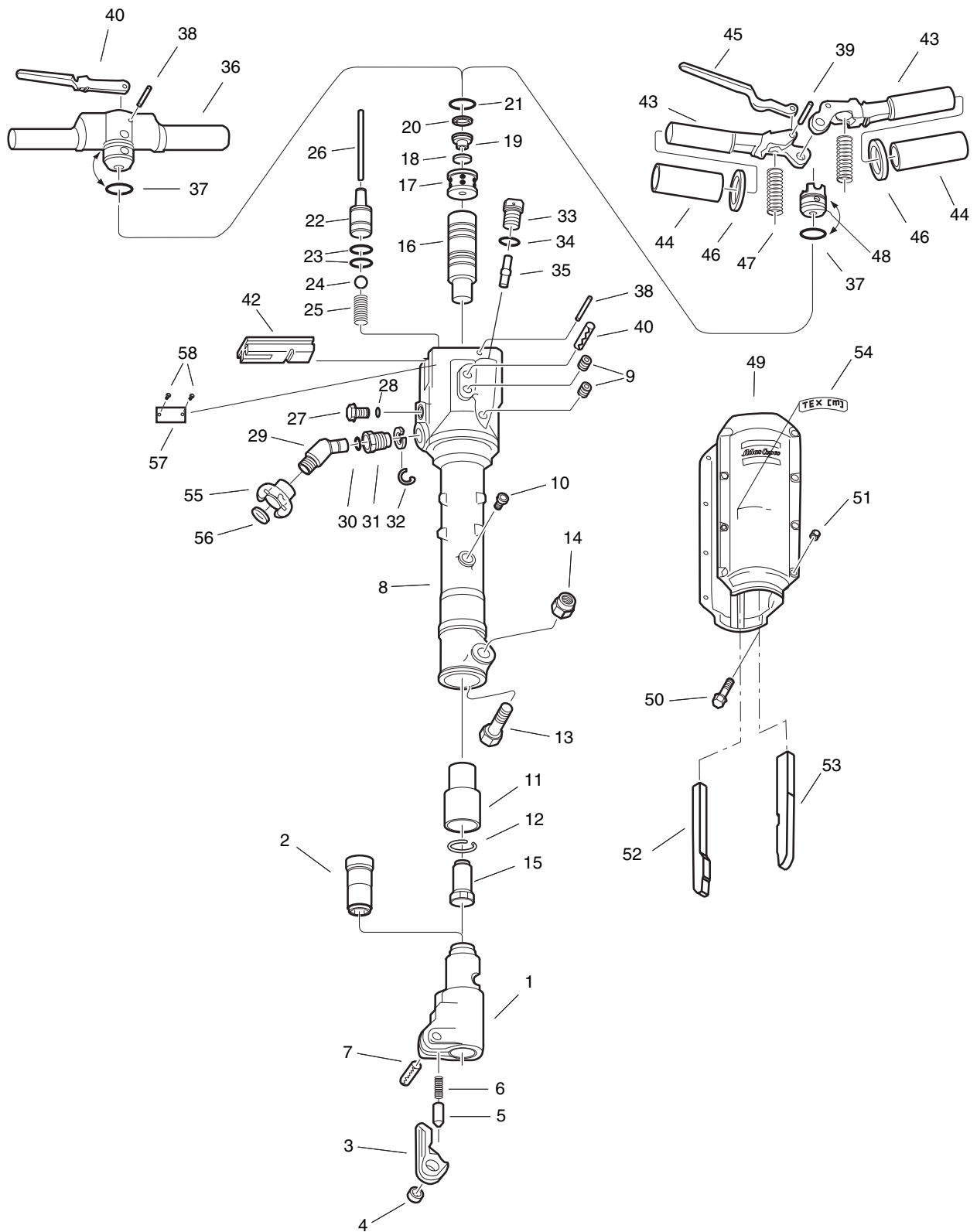











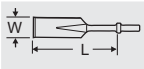

No.	Ordering No.	Quantity						Description	Dimensions
		18PS	19PE	22PS	23PE	27PS	28PE		
47	3310 1083 00	-	2	-	2	-	2	Spring	
48	3310 1159 00	-	1	-	1	-	1	Seal plug	
(49-53)	3310 1319 80	1	1	-	-	-	-	Silencer, compl., 18PS, 19PE	
49	—*)	1	1	-	-	-	-	– Silencer	
50	0147 1976 05	6	6	-	-	-	-	– Flange screw	M6x50 mm
51	9232 0207 50	6	6	-	-	-	-	– Flange nut	M6 Triloc
52	3310 1320 00	1	1	-	-	-	-	– Separation wall	Back
53	3310 1321 00	1	1	-	-	-	-	– Separation wall	Front
(49-53)	3310 1318 80	-	-	1	1	-	-	Silencer, compl., 22PS, 23PE	
49	—*)	-	-	1	1	-	-	– Silencer	
50	0147 1976 05	-	-	8	8	-	-	– Flange screw	M6x50 mm
51	9232 0207 50	-	-	8	8	-	-	– Flange nut	M6 Triloc
52	3310 1322 00	-	-	1	1	-	-	– Separation wall	Back
53	3310 1323 00	-	-	1	1	-	-	– Separation wall	Front
(49-53)	3310 1318 81	-	-	-	-	1	1	Silencer, compl., 27PS, 28PE	
49	—*)	-	-	-	-	1	1	– Silencer	
50	0147 1976 05	-	-	-	-	8	8	– Flange screw	M6x50 mm
51	9232 0207 50	-	-	-	-	8	8	– Flange nut	M6 Triloc
52	3310 1324 00	-	-	-	-	1	1	– Separation wall	Back
53	3310 1325 00	-	-	-	-	1	1	– Separation wall	Front
54	3310 1114 01	1	-	-	-	-	-	Plate TEX 18PS	
54	3310 1114 02	-	1	-	-	-	-	Plate TEX 19PE	
54	3310 1086 01	-	-	1	-	-	-	Plate TEX 22PS	
54	3310 1086 02	-	-	-	1	-	-	Plate TEX 23PE	
54	3310 1096 01	-	-	-	-	1	-	Plate TEX 27PS	
54	3310 1096 02	-	-	-	-	-	1	Plate TEX 28PE	
(55-56)	9000 0306 00	1	1	1	1	1	1	Claw coupling, compl. ISO models	G 3/4
55	—*)	1	1	1	1	1	1	– Claw coupling	
56	9000 0000 00**)	1	1	1	1	1	1	– Packing	G 3/4
(55-56)	9001 0005 06	1	1	1	1	1	1	Claw coupling, compl, US-models	3/4-14NPT
55	—*)	1	1	1	1	1	1	– Claw coupling	
56	9001 0005 15	1	1	1	1	1	1	– Packing	NPT
57	—*)	1	1	1	1	1	1	Data plate	
58	0244 4144 00	2	2	2	2	2	2	Screw	

*) Not delivered separately.

***) Included in Service kit 3310 1175 90/91, see page 12.











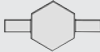
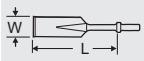

Working Tools

TEX 18PS, 19PE, 22PS, 23PE, 27 PS, 28 PE

Point to flat (ISO) 												
	22 x 82.5 mm (7/8 x 3 1/4 in.)			25 x 108 mm (1 x 1 1/4 in.)			28 x 160 mm (1 1/8 x 6 1/4 in.)			32 x 160 mm (1 1/4 x 6 1/4 in.)		
	W (mm)	L (mm)	Part no.	W (mm)	L (mm)	Part no.	W (mm)	L (mm)	Part no.	W (mm)	L (mm)	Part no.
Moil point		380	3083 3242 00	380	3083 3253 00		380	3083 3271 00		380	3083 3205 00	
		1000	3083 3243 00				450	3083 3272 00		450	3083 3206 00	
							1000	3083 3273 00		1000	3083 3207 00	
Narrow chisel	25	380	3083 3244 00	28	380	3083 3254 00	32	380	3083 3274 00	35	380	3083 3208 00
												
	25	1000	3083 3245 00				32	450	3083 3275 00	35	450	3083 3209 00
							32	1000	3083 3276 00	35	1000	3083 3210 00
Wide chisel	75	380	3083 3246 00	75	380	3083 3255 00	75	380	3083 3277 00	75	380	3083 3211 00
												
Wedge chisel	35	380	3083 3250 00	35	380	3083 3258 00	40	400	3083 3282 00	40	400	3083 3216 00
												
Digging chisel	75	380	3083 3247 00	75	380	3083 3256 00	75	380	3083 3279 00	75	380	3083 3213 00
												
Digging spade	120	380	3083 3248 00	120	380	3083 3257 00	125	380	3083 3280 00	125	380	3083 3214 00
												
Asphalt cutter	125	380	3083 3069 00				115	300	3083 3278 00	115	300	3083 3212 00
												
Clay spade	125	430	3083 3249 00	125	430	3083 3033 00	140	380	3083 3281 00	140	380	3083 3215 00
												
Shaft for pad		310	3083 3251 00	280	3083 3259 00		230	3083 3283 01		235	3083 3218 01	
												
Tamping pad, round	175		3083 3252 10	175		3083 3252 10	180		3083 3301 00	180		3083 3301 00
												
Tamping pad, square	175		3083 3239 00	175		3083 3239 00	150		3083 3302 00	150		3083 3302 00
												
Driver pad, round	100		9245 2817 90	100		9245 2817 90	200		3083 3197 00	200		3083 3197 00
												

Working Tools - US models

TEX 18PS US, 19PE US, 22PS US, 23PE US, 27 PS US, 28 PE US

	Flat to flat (North America) 						Point to flat (North America) 					
	7/8 x 3 1/4 in.(22 x 82.5 mm)			1 x 1 1/4 in.(25 x 108 mm)			1 1/8 x 6 1/4 in.(28 x 160 mm)			1 1/4 x 6 1/4 in.(32 x 160 mm)		
	W (in)	L (in)	Part no.	W (in)	L (in)	Part no.	W (in)	L (in)	Part no.	W (in)	L (in)	Part no.
Moil point 		14	3083 4050 00		15	3083 4030 00		14	3083 3267 00		14	3083 3285 00
		18	3083 4050 10		18	3083 4030 10		18	3083 4015 10		18	3083 4000 10
		24	3083 4050 20		24	3083 4030 20		24	3083 4015 20		24	3083 4000 20
Narrow chisel 	1	14	3083 3303 00	1 1/8	15	3083 3309 00	1 1/4	14	3083 3268 00	1 3/8	14	3083 3286 00
	1	18	3083 4051 10	1 1/8	18	3083 4031 10	1 1/4	18	3083 4016 10	1 3/8	18	3083 4001 10
	1	24	3083 3304 00	1 1/8	24	3083 4031 20	1 1/4	24	3083 4016 20	1 3/8	24	3083 4001 20
Wide chisel 	3	14	3083 3305 00	3	15	3083 3310 00	3	15	3083 3289 00	3	15	3083 3295 00
	3	18	3083 4052 10	3	18	3083 4032 00	3	18	3083 4017 00	3	18	3083 4002 00
Wedge chisel 	1 3/8	15	3083 4057 00	2	15	3083 3313 00	2	16	3083 3294 00	2	16	3083 3300 00
Digging chisel 	3	14	3083 3306 00	3	15	3083 3311 00	3	15	3083 3291 00	3	15	3083 3297 00
Digging spade 	4 3/4	13	3083 3307 00	4 3/4	13	3083 3312 00	5	13	3083 3292 00	5	13	3083 3298 00
Asphalt cutter 	5	12	3083 4053 00	5	13	3083 4033 00	5	13	3083 3290 00	5	13	3083 3296 00
Clay spade 	5	17	3083 3308 00	5	16	3083 4035 00	5 1/2	15	3083 3293 00	5 1/2	15	3083 3299 00
Shaft for pad 		8	3083 4058 00		11	3083 4037 00		9	3083 3269 00		9	3083 3287 00
Tamping pad, round 	7		3083 3252 10	7		3083 3252 10	7		3083 3301 00	7		3083 3301 00
Tamping pad, square 	7		3083 3239 00	7		3083 3239 00	6		3083 3302 00	6		3083 3302 00
							8		3083 3197 00	8		3083 3197 00
Driver pad, round 	4		9245 2817 90	4		9245 2817 90						

Service kit 3310 1175 91

TEX 19PE 23PE 28PE Not for US-models

No.	Ordering No.	Quantity			Description	Dimensions
		19PE	23PE	28PE		
-	3310 1175 91	1	1	1	Service kit	
13	3310 1175 00	1	1	1	- Bolt	MJ20x100
14	0291 1116 00	1	1	1	- Nut	M20 Nyloc
21	0663 2101 09	1	1	1	- O-ring	Ø40.64x5.33
23	0663 2105 43	2	2	2	- O-ring	Ø27.6x2.4
28	0663 2116 00	1	1	1	- O-ring	Ø9.3x2.4
30, 34	0663 2126 00	2	2	2	- O-ring	Ø22.2x3
37	0663 2135 00	1	1	1	- O-ring	Ø44.2x3.0
39	0108 1330 00	2	2	2	- Spring pin	Ø6x32
41	0108 1690 86	1	1	1	- Connex pin	Ø16x85
44	3310 1132 00	2	2	2	- Sleeve	
46	3310 1085 00	2	2	2	- Rubber washer	
56	9000 0000 00	1	1	1	- Packing	G 3/4

Service kit 3310 1175 90

TEX 18PS 22PS 27PS Not for US-models

No.	Ordering No.	Quantity			Description	Dimensions
		19PE	23PE	28PE		
-	3310 1175 90	1	1	1	Service kit	
13	3310 1175 00	1	1	1	- Bolt	MJ20x100 mm
14	0291 1116 00	1	1	1	- Nut	M20 Nyloc
21	0663 2101 09	1	1	1	- O-ring	Ø40.64x5.33
23	0663 2105 43	2	2	2	- O-ring	Ø27.6x2.4
28	0663 2116 00	1	1	1	- O-ring	Ø9.3x2.4
30, 34	0663 2126 00	2	2	2	- O-ring	Ø22.2x3
37	0663 2135 00	1	1	1	- O-ring	Ø44.2x3.0
39	0108 1330 00	1	1	1	- Spring pin	Ø6x32
41	0108 1690 86	1	1	1	- Connex pin	Ø16x85
56	9000 0000 00	1	1	1	- Packing	G 3/4

Air oil

Ordering No.	Description	Dimensions
8099 0202 40	Air oil bottle 0,2 l	0,2 l
8099 0202 36	Air oil bottle 1 l	1 l
8099 0202 02	Air oil container 5 l	5 l
8099 0202 20	Air oil container 25 l	25 l
8099 0202 28	Air oil barrel 200 l	200 l



Shank gauge

Ordering No.	Description	Dimensions
3310 1509 25	Gauge, Hex 25	25 mm
3310 1509 28	Gauge, Hex 28	28 mm
3310 1509 32	Gauge, Hex 32	32 mm

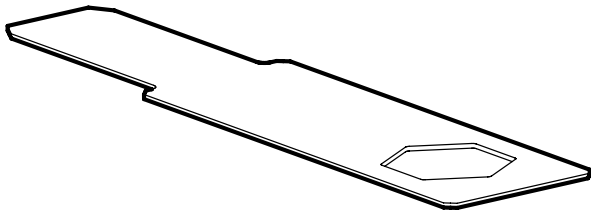

Use only authorized parts. Any damage or malfunction caused by the use of unauthorized parts is not covered by Warranty or Product Liability



Any unauthorized use or copying of the contents or any part thereof is prohibited.
This applies in particular to trademarks, model denominations, part numbers and drawings.

© 2007 Atlas Copco Construction Tools AB, Stockholm, Sweden | No. 9853 6035 90i | 2007-04-04